

LED Headlights - Model 8820

PRODUCT INFORMATION

Description	12-24 DOT/ECE LED RHT High & Low Beam Headlight with FP & Panel Mount
Height	129.79 mm / 5.11 in
Width	168.66 mm / 6.64 in
Depth	87.38 mm / 3.44 in
Shape	Rectangular
Outer Lens Material	Polycarbonate
Outer Lens Color	Clear
Housing Material	Aluminum
Housing Color	Black
Bezel Color	Black
Mounting Type	Panel Mount
Connector or Wiring	12" Flying Leads
Product Weight	2.50 lbs / 1.13 kgs
Shipping Weight	1.71 lbs / 0.78 kgs



PRODUCT DIMENSIONS

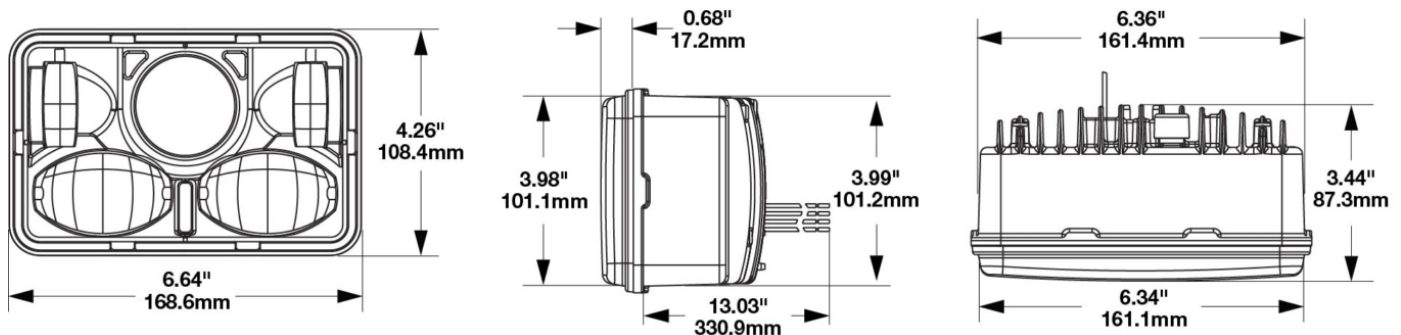

Print date: 2024-08-11

© 2024 J.W. Speaker Corporation • Germantown, WI U.S.A.
www.jwspeaker.com • speaker@jwspeaker.com • 262.251.6660

J.W. SPEAKER
 Engineered. Lighting. Solutions.

LED Headlights - Model 8820

ELECTRICAL SPECIFICATIONS

Input Voltage	12-24V DC
Operating Voltage	10-30V DC
Black Wire	Ground
White Wire	High Beam
Yellow Wire	Low Beam
Red Wire	Front Position
Current Draw	1.11A @ 12V DC (Low Beam) 0.96A @ 24V DC (Low Beam) 2.14A @ 12V DC (High Beam) 1.56A @ 24V DC (High Beam) 0.056A @ 12V DC (Front Position) 0.065A @ 24V DC (Front Position)

REGULATORY STANDARDS COMPLIANCE



Buy America Standards	ECE Reg 112
ECE Reg 7	Eco Friendly
FMVSS 108 s10.1 (Table XIX)	FMVSS 108 s10.1 (Table XVIII)
IEC IP67	

Print date: 2024-08-11

© 2024 J.W. Speaker Corporation • Germantown, WI U.S.A.
www.jwspeaker.com • speaker@jwspeaker.com • 262.251.6660

J.W. SPEAKER
Engineered. Lighting. Solutions.

LED Headlights - Model 8820

PHOTOMETRIC SPECIFICATIONS

Raw Lumen Output	2,100 (High Beam); 1,850 (Low Beam)
Effective Lumen Output	755 (High Beam); 645 (Low Beam)
Beam Pattern(s)	Forward Lighting - High Beam (DOT/ECE) Forward Lighting - Low Beam (DOT) Forward Lighting - Low Beam (ECE Right Hand) Signalization - Front Position

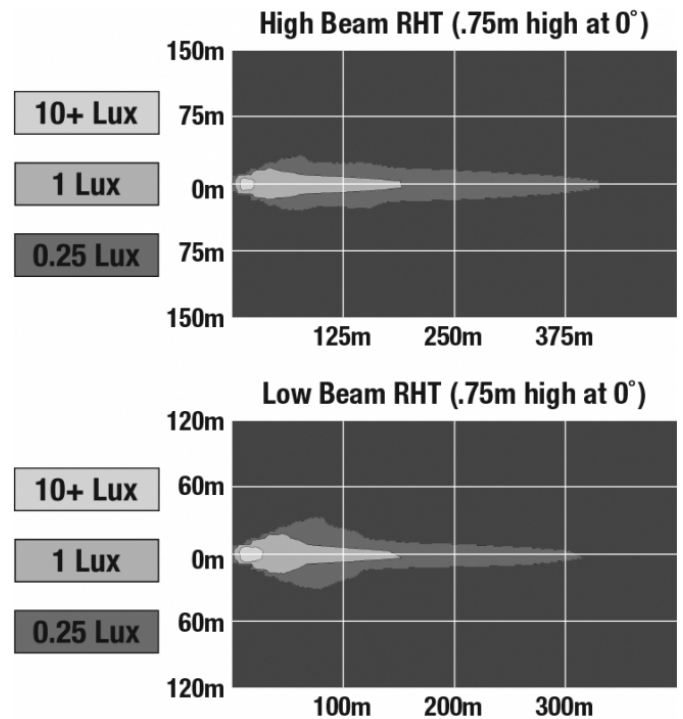

APPLICATIONS



PRODUCT WARNINGS

For California residents:

⚠️ **WARNING:** Cancer and reproductive harm - www.P65Warnings.ca.gov.

⚠️ **AVERTISSEMENT:** Cancer et effet nocif sur la reproduction - www.P65Warnings.ca.gov.

Print date: 2024-08-11

© 2024 J.W. Speaker Corporation • Germantown, WI U.S.A.
www.jwspeaker.com • speaker@jwspeaker.com • 262.251.6660

J.W. SPEAKER
Engineered. Lighting. Solutions.

LED Headlights - Model 8820

RELATED PRODUCTS



Part Number
0550271
12-24 DOT/ECE LED
RHT High & Low Beam
Headlight with FP & 3
Point Mount



Part Number
0550281
12-24 ECE LED LHT
High & Low Beam
Headlight with FP & 3
Point Mount



Part Number
0550941
12-24 ECE LED LHT
High & Low Beam
Headlight with FP &
Panel Mount